

# Sirocco

Rotačná (karuselová) pec / Rack rotating oven

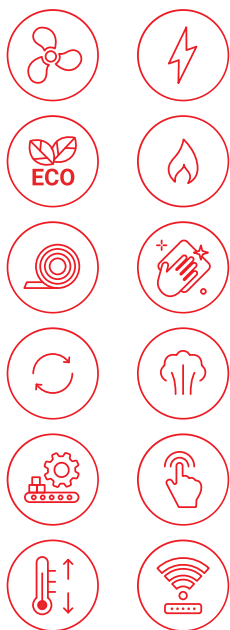

Už je to 20 rokov odkedy spoločnosť Salva uviedla na trh svoj rad produktov Sirocco. Počas tejto doby boli pridané modely, aby sa prispôsobili meniacemu sa trhu.

Predstavujeme druhú generáciu tohto radu pre nové tisícročie - SIROCCO EVOLUTION.

Tento nový produktový rad bol vyvinutý vďaka skúsenostiam z pozorovania používania tohto produktu u pekárov a cukrárov, z aplikovania všetkých vylepšení, ktoré nám navrhli, z využitia technológií na dizajn produktov a znamená pokročilejšiu výrobu.

To všetko viedlo k robustnej a spoľahlivej rúre, ktorá je schopná zabezpečiť pravidelné a homogénne pečenie, pri ktorom sa získajú lesklé, dobre vyvinuté bochníky s textúrou a chuťou, ktorú vyžaduje aj ten najnáročnejší pekáč.

Rad SIROCCO EVOLUTION je koncipovaný podľa 5 princípov:

- Kvalita pečenia
- Robustnosť a spoľahlivosť
- Všestrannosť
- Jednoduchosť
- Ekonomika

#### Modely:

SK: Pre plechy 60x40, 66x46, 75x45, 80x40, 80x46

SR: Pre plechy 80x60

SP: Pre plechy 90x65, 92x66, 100x80, 110x65

*Its 20 years now since Salva launched their range of Sirocco Rack Rotating Ovens. The market has changed during these years, and different models have been added and marked improvements made to the range.*

*We are now about to launch the second generation of Sirocco ovens for the new millennium, and this range we have called SIROCCO EVOLUTION.*

*This new Sirocco is the result of experience gained by first seeing how bakers have used this product in the past, secondly of having applied all the improvement suggested, and finally of having tested new product design technologies and employed the most advanced production means. Thanks to all this, we have got a strong and extremely reliable oven, that is capable of providing regular and uniform bake with well developed and shiny loaves, that have the texture and flavour that the most demanding baker requires. This is the SIROCCO EVOLUTION.*

*The SIROCCO EVOLUTION range is conceived under 5 principals:*

- Quality of Baking
- Strength and Reliability
- Versatility
- Easiness of use
- Economy

#### Models:

**SK:** for trays 60x40, 66x46, 75x45, 80x40, 80x46

**SR:** for trays 80x60

**SP:** for trays 90x65, 92x66, 100x80, 110x65

# Sirocco

Rotačná (karuselová) pec / *Rack rotating oven*

Technická charakteristika / *Technical characteristics*



| PEC<br>OVEN                   | Elect.<br>Kw | Elect.<br>kcal/h | Max. výkon<br>Max. Power<br>kw-kcal/h | Počet fáz<br>Phases | V                     | A          | HZ        | Objem<br>Volume<br>dm <sup>3</sup>             | Max. počet plechov<br>N° Trays Max. |             |
|-------------------------------|--------------|------------------|---------------------------------------|---------------------|-----------------------|------------|-----------|--|-------------------------------------|-------------|
| SK-21-E<br>SK-22-E<br>SK-23-E | 42,5         | 36.700           | 49-42.336                             | 3N~                 | 230                   | 107        | 50        | 589  | 14-16-18-20                         |             |
| 400                           |              |                  |                                       |                     | 62                    | 608        |           | 80X40 / 80X46 / 75X45<br>70X50 / 60X40 / 66X46 |                                     |             |
| SK-21-C<br>SK-22-C<br>SK-23-C | 0,5          | -                |                                       | 3N~                 | 230/400               | 2,5/1,5    | 50        | 589  | 14-16-18-20                         |             |
| 608                           |              |                  |                                       |                     | 70X50 / 60X40 / 66X46 |            |           |  |                                     |             |
| SR-21-E<br>SR-22-E<br>SR-23-E | 57           | 49.250           |                                       | 67-57888            | 3N~                   | 230        | 144       | 50   | 768                                 | 14-16-18-20 |
| 400                           |              |                  |                                       |                     |                       | 83         | (80 X 60) |  |                                     |             |
| SR-21-C<br>SR-22-C<br>SR-23-C | 1            | -                | 3N~                                   |                     | 230/400               | 3,5/2      | 50        | 768  | 14-16-18-20                         |             |
| (80 X 60)                     |              |                  |                                       |                     |                       |            |           |  |                                     |             |
| SP-21-E<br>SP-22-E<br>SP-23-E | 78           | 67.400           | 96-82947                              | 3N~                 | 230                   | 197        | 50        | 1280   | 14-16-18-20                         |             |
| 400                           |              |                  |                                       |                     | 113                   | (100 X 80) |           |  |                                     |             |
| SP-21-C<br>SP-22-C<br>SP-23-C | 1            | -                |                                       | 3N~                 | 230/400               | 3,5/2      | 50        | 1280   | 14-16-18-20                         |             |
| (100 X 80)                    |              |                  |                                       |                     |                       |            |           |  |                                     |             |

# Sirocco

Rotačná (karuselová) pec / Rack rotating oven

Rozmery / Dimensions

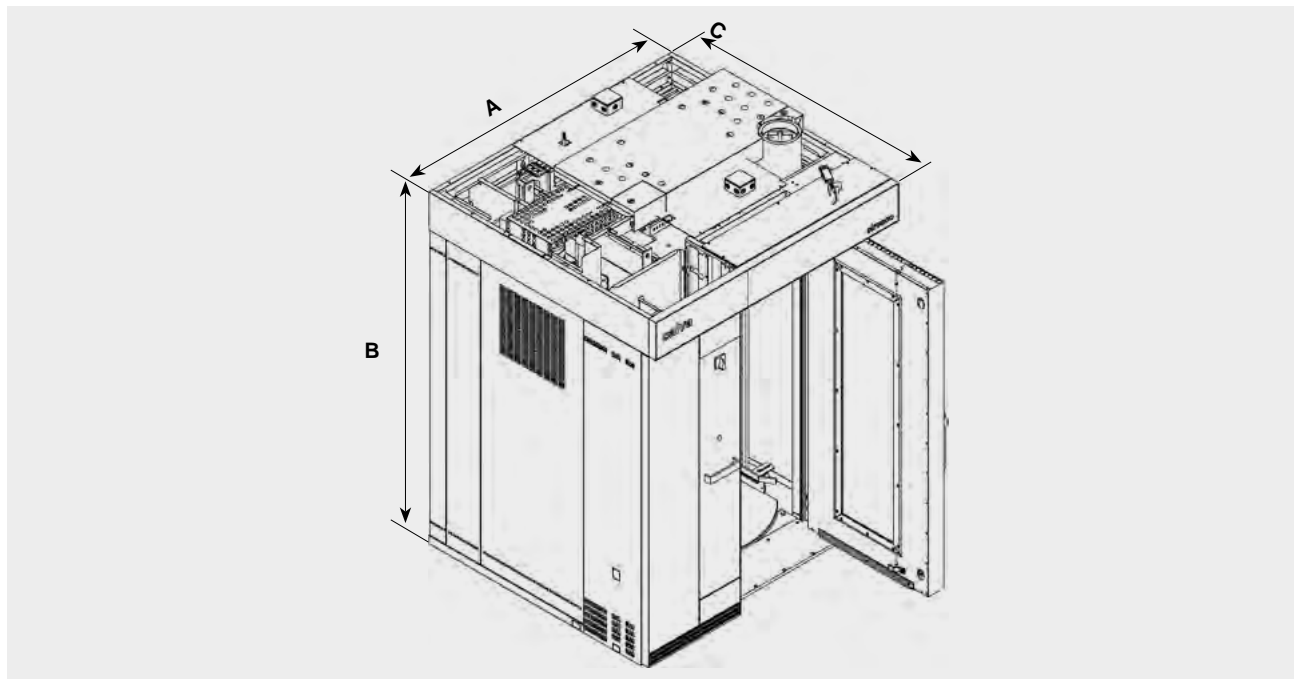

| PEC<br>OVEN | A<br>mm | B<br>mm | C<br>mm | Hmotnosť / Weig<br>kg |
|-------------|---------|---------|---------|-----------------------|
| SK-21-E     | 1.665   | 2.197   | 1.557   | 1.100                 |
| SK-22-E     | 1.275   | 2.197   | 1.957   |                       |
| SK-23-E     | 1.275   | 2.197   | 1.957   |                       |
| SK-21-C     | 1.665   | 2.197   | 1.557   |                       |
| SK-22-C     | 1.275   | 2.197   | 1.957   |                       |
| SK-23-C     | 1.275   | 2.197   | 1.957   |                       |
| SR-21-E     | 2.022   | 2.197   | 1.791   | 1.370                 |
| SR-22-E     | 1.581   | 2.197   | 2.281   |                       |
| SR-23-E     | 1.581   | 2.197   | 2.281   |                       |
| SR-21-C     | 2.022   | 2.197   | 1.791   |                       |
| SR-22-C     | 1.581   | 2.197   | 2.281   |                       |
| SR-23-C     | 1.581   | 2.197   | 2.281   |                       |
| SP-21-E     | 2.258   | 2.197   | 2.079   | 1.480                 |
| SP-22-E     | 1.758   | 2.197   | 2.502   |                       |
| SP-23-E     | 1.758   | 2.197   | 2.502   |                       |
| SP-21-C     | 2.258   | 2.197   | 2.079   |                       |
| SP-22-C     | 1.758   | 2.197   | 2.502   |                       |
| SP-23-C     | 1.758   | 2.197   | 2.502   |                       |

# Sirocco

Rotačná (karuselová) pec / Rack rotating oven

Rozmery / Dimensions

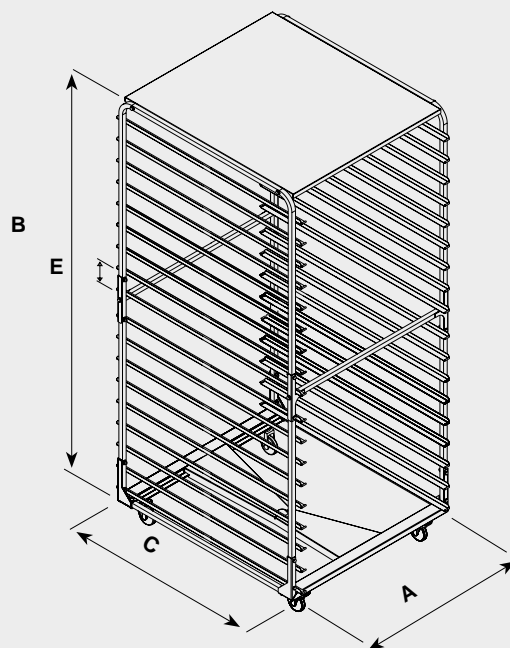

| REGÁLOVÝ VOZÍK<br>RACK | A<br>mm | B<br>mm | C<br>mm |
|------------------------|---------|---------|---------|
| BSK/02 60 X 40         | 614     | 1.792   | 456     |
| BSK/02 66 X 46         | 674     | 1.792   | 516     |
| BSK/02 70 X 50         | 714     | 1.792   | 556     |
| BSK/02 75 X 45         | 764     | 1.792   | 506     |
| BSK/02 76 X 50         | 774     | 1.792   | 556     |
| BSK/02 80 X 40         | 814     | 1.792   | 456     |
| BSK/02 80 X 46         | 814     | 1.792   | 516     |
| BSR/03 80 X 60         | 814     | 1.792   | 660     |
| BSR/03 78 X 58         | 714     | 1.792   | 640     |
| BSR/03 80 X 50         | 814     | 1.792   | 560     |
| BSP/03 100 X 80        | 1.014   | 1.792   | 860     |
| BSP/03 66 X 46         | 880     | 1.792   | 717     |

| E<br>mm<br>ZÁSUVY / LEVELS |       |
|----------------------------|-------|
| 14                         | 114,5 |
| 16                         | 100,2 |
| 18                         | 89    |
| 20                         | 80    |

# Sirocco

Rotačná (karuselová) pec / *Rack rotating oven*

Ovládacie panely / *Control panel*

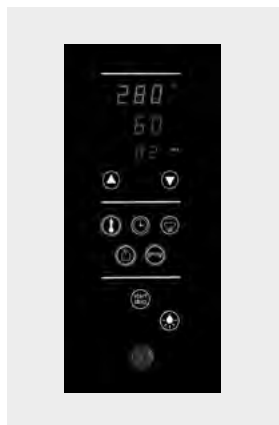

## STANDARD

- Jednoduché programovanie a obsluha / *Easy to program and use.*
- TOUCH CONTROL.
- Veľké znaky / *Large digits.*
- Automatické riadenie nástreľu / *Automatic shot control.*
- Parametre energetickej účinnosti: / *Energy Efficiency Parameters:*
  - ECO (Auto Off) / *ECO-Parameter (Auto Off).*
  - ECU (Efektívne udržiavanie teploty). / *Parameter ECU (Efficient temperature maintenance).*
- Načítanie programu a verzií pomocou firmvéru / *Loading programs and versions through FIRMWARE.*

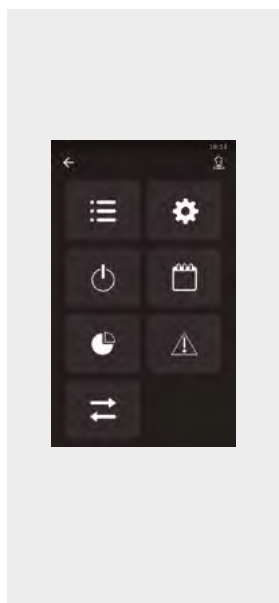

## SMART TOUCH CONTROL STC

- Grafický displej 7" / *Graphic display of 7"*
- Možnosť editovať programy cez fotografie / *Possibility of editing recipes with photographs*
- Knižnica piktogramov / *Built-in pictogram library.*
- 150 programov, každý s 10 fázami / *150 programs 10 phases in each.*
- Riadenie energetickej účinnosti. / *Energy efficiency management.*
- Kalendár - časovač / *Timed Start Calendar.*
- Automatické riadenie nástreľu / *Automatic shot control.*
- Parametre energetickej účinnosti: / *Energy Efficiency Parameters.*
  - ECO (Auto Off). / *ECO parameter (Auto Off).*
  - ECU (Efektívne udržiavanie teploty). / *Parameter ECU (Efficient temperature maintenance).*
- Funkcia čiastočné naloženie - Flex Baking. / *Partial load function Flex Baking.*
- Načítanie programu a nových verzií pomocou firmvéru. / *Loading programs and versions through Firmware.*
- Možnosť pripojenia k webu: Salvalink 2.0. / *Possibility of web connection: Salvalink 2.0.*

Technický prístup k horákovi alebo elektrickým odporom  
*Technical Access To Burner Or Electrical Resistances*

Model 21 / Deck 21

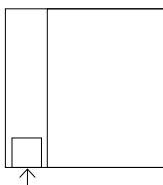

Model 22 / Deck 22

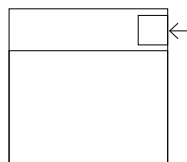

Model 23 / Deck 23

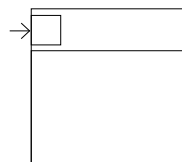

# Sirocco SK

## Rotačná (karuselová) pec / Rack rotating oven

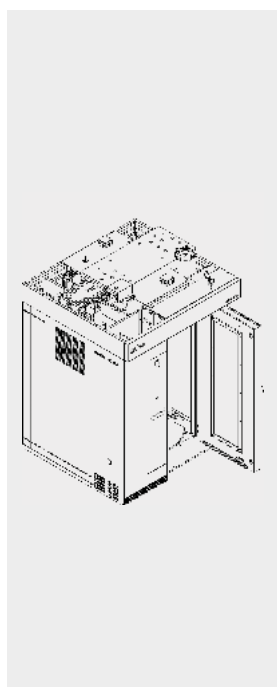

| UMIESTNENIE VÝMENNÍKA TEPLA: VĽAVO / SITUATION OF HEAT EXCHANGER: LEFT |  |                |     |
|--|--|----------------|-----|
| PRÍSTUP K HORÁKU: PREDNÝ / ACCES TO BURNER: FRONT                      |  |                |     |
| KÓD / Code   | POPIS / Description  | CENA / Price € |     |
|  |  | Standard       | STC |
| 1330030001   | SK-21-C+V/14 400V Bez horáka<br>SK-21-C+V/14 400V Without burner                 |                |     |
| 1330030000   | SK-21-C+V/03 230V Bez horáka<br>SK-21-C+V/14 230V Without burner                 |                |     |
| 1330040001   | SK-21-E+V/14 400V EL<br>SK-21-E+V/14 400V Electric                               |                |     |
| 1330040000   | SK-21-E+V/14 230V EL<br>SK-21-E+V/14 230V Electric                               |                |     |
| 1330020001   | SK-21-G+V/14 400V S plynovým horákom<br>SK-21-G+V/14 400V Includes gas burner    |                |     |
| 1330020000   | SK-21-G+V/14 230V S plynovým horákom<br>SK-21-G+V/14 230V Includes gas burner    |                |     |
| 1330010001   | SK-21-O+V/14 400V S plynovým horákom<br>SK-21-O+V/14 400V Includes diesel burner |                |     |
| 1330010000   | SK-21-O+V/14 230V S plynovým horákom<br>SK-21-O+V/14 230V Includes diesel burner |                |     |

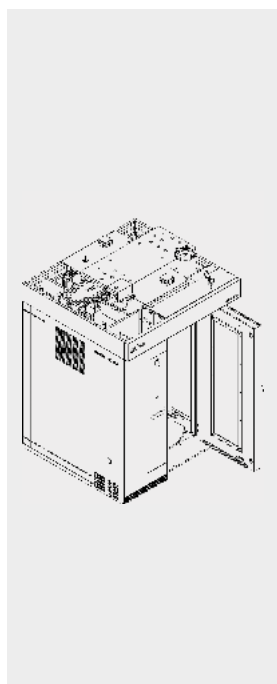

| UMIESTNENIE VÝMENNÍKA TEPLA: VZADU / SITUATION OF HEAT EXCHANGER: BACK |  |                |     |
|--|--|----------------|-----|
| PRÍSTUP K HORÁKU: VPRAVO / ACCES TO BURNER: RIGHT                      |  |                |     |
| KÓD / Code   | POPIS / Description  | CENA / Price € |     |
|  |  | Standard       | STC |
| 1330430001   | SK-22-C+V/14 400V Bez horáka<br>SK-22-C+V/14 400V Without burner                 |                |     |
| 1330430000   | SK-22-C+V/14 230V Bez horáka<br>SK-22-C+V/14 230V Without burner                 |                |     |
| 1330440001   | SK-22-E+V/14 400V EL<br>SK-22-E+V/14 400V Electric                               |                |     |
| 1330440000   | SK-22-E+V/14 230V EL<br>SK-22-E+V/14 230V Electric                               |                |     |
| 1330420001   | SK-22-G+V/14 400V S plynovým horákom<br>SK-22-G+V/14 400V Includes gas burner    |                |     |
| 1330420000   | SK-22-G+V/14 230V S plynovým horákom<br>SK-22-G+V/14 230V Includes gas burner    |                |     |
| 1330410001   | SK-22-O+V/14 400V S olejovým horákom<br>SK-22-O+V/14 400V Includes diesel burner |                |     |
| 1330410000   | SK-22-O+V/14 230V S olejovým horákom<br>SK-22-O+V/14 230V Includes diesel burner |                |     |

Pec Sirocco 60hz + 3%.  
Sirocco oven at 60hz + 3%.

# Sirocco SK

Rotačná (karuselová) pec / Rack rotating oven

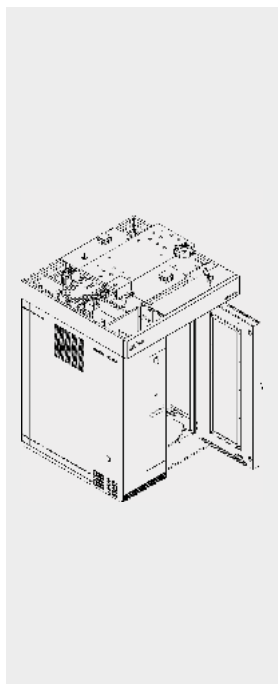

| UMIESTNENIE VÝMENNÍKA TEPLA: VZADU / SITUATION OF HEAT EXCHANGER: <b>BACK</b> |  |                |     |
|---|--|----------------|-----|
| PRÍSTUP K HORÁKU: VĽAVO / ACCES TO BURNER: <b>LEFT</b>                        |  |                |     |
| KÓD / Code  | POPIS / Description  | CENA / Price € |     |
|   |  | Standard       | STC |
| 1330730001  | SK-23-C+V/14 400V Bez horáku<br>SK-23-C+V/14 400V Without burner                 |                |     |
| 1330730000  | SK-23-C+V/14 230V Bez horáku<br>SK-23-C+V/14 230V Without burner                 |                |     |
| 1330740001  | SK-23-E+V/14 400V EL<br>SK-23-E+V/14 400V Electric                               |                |     |
| 1330740000  | SK-23-E+V/14 230V EL<br>SK-23-E+V/14 230V Electric                               |                |     |
| 1330720001  | SK-23+G+V/14 400V S plynovým horákom<br>SK-23+G+V/14 400V Includes gas burner    |                |     |
| 1330720000  | SK-23+G+V/14 230V S plynovým horákom<br>SK-23+G+V/14 230V Includes gas burner    |                |     |
| 1330710001  | SK-23-O+V/14 400V S olejovým horákom<br>SK-23-O+V/14 400V Includes diesel burner |                |     |
| 1330710000  | SK-23-O+V/14 230V S olejovým horákom<br>SK-23-O+V/14 230V Includes diesel burner |                |     |

pec Sirocco 60hz + 3%.  
Sirocco oven at 60hz + 3%.

# Sirocco SK

Rotačná (karuselová) pec / Rack rotating oven

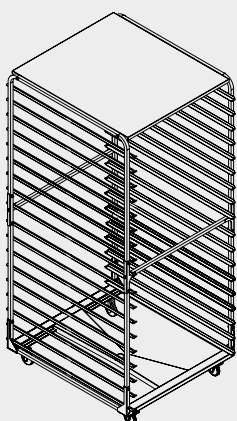

| ZAVÁŽACÍ VOZÍK / RACK |  |                |
|-----------------------|--|----------------|
| KÓD / Code            | POPIS / Description  | CENA / Price € |
| 2039220000            | BSK-16/02 60X40 (16 zásuvov 60x40)<br>BSK-16/02 60X40 (16 levels 60x40)  |                |
| 2039230000            | BSK-18/02 60X40 (18 zásuvov 60x40) BSK-18/02<br>60X40 (18 levels 60x40)  |                |
| 2039240000            | BSK-20/02 60X40 (20 zásuvov 60x40)<br>BSK-20/02 60X40 (20 levels 60x40)  |                |
| 2039226646            | BSK-16/02 66X46 USA (16 zásuvov 66x46)<br>BSK-16/02 66X46 USA (16 levels 66x46)  |                |
| 2039236646            | BSK-18/02 66X46 USA (18 zásuvov 66x46)<br>BSK-18/02 66X46 USA (18 levels 66x46)  |                |
| 2039217050            | BSK-14/02 70X50 (14 zásuvov 70x50)<br>BSK-14/02 70X50 (14 levels 70x50)  |                |
| 2039227050            | BSK-16/02 70X50 (16 zásuvov 70x50)<br>BSK-16/02 70X50 (16 levels 70x50)  |                |
| 2039227545            | BSK-16/02 75X45 (16 zásuvov 75x45)<br>BSK-16/02 75X45 (16 levels 75x45)  |                |
| 2039237545            | BSK-18/02 75X45 (18 zásuvov 75x45)<br>BSK-18/02 75X45 (18 levels 75x45)  |                |
| 2039228040            | BSK-16/02 80X40 (16 zásuvov 80x40)<br>BSK-16/02 80X40 (16 levels 80x40)  |                |
| 2039238040            | BSK-18/02 80X40 (18 zásuvov 80x40)<br>BSK-18/02 80X40 (18 levels 80x40)  |                |
| 2039228046            | BSK-16/02 80X46 (16 zásuvov 80x46)<br>BSK-16/02 80X46 (16 levels 80x46)  |                |
| 2039238046            | BSK-18/02 80X46 (18 zásuvov 80x46)<br>BSK-18/02 80X46 (18 levels 80x46)  |                |
| 2039229020            | BSK-16/19 80X40 (16 zásuvov 80x40) VYSTRUŽENÉ - VYŠŠIA ZÁŤAŽ<br>BSK-16/19 80X40 (16 levels 80x40) REINFORCED HIGH LOAD |                |
| 2039229000            | BSK-16/19 80X46 (16 zásuvov 80x46) VYSTRUŽENÉ - VYŠŠIA ZÁŤAŽ<br>BSK-16/19 80X46 (16 levels 80x46) REINFORCED HIGH LOAD |                |



# Sirocco SK

Rotačná (karuselová) pec / Rack rotating oven

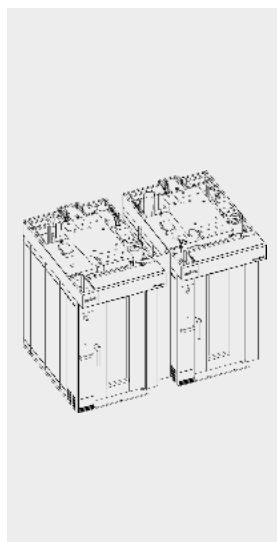

| KIT / KIT  |  |                |
|------------|--|----------------|
| KÓD / Code | POPIS / Description  | CENA / Price € |
| 1330013013 | MOTORIZOVANÝ KOMÍN SIR/14<br>MOTORIZED FLUE SIR/14                                       |                |
| 1330016100 | INTEGROVANÝ SYSTÉM ODVODU SPALÍN SK-21<br>IES (INTEGRATED EXHAUST SYSTEM) SK-21          |                |
| 1330416100 | INTEGROVANÝ SYSTÉM ODVODU SPALÍN SK-22-23<br>IES (INTEGRATED EXHAUST SYSTEM) SK-22-23    |                |
| 1330413008 | KIT SK-G,O/14 SPOJENIE SÚSTAVY PECÍ<br>KIT SK-G,O/14 OF ALINED OVENS                     |                |
| 1330443001 | KIT SK-E/14 SPOJENIE SÚSTAVY PECÍ<br>KIT SK-E/14 OF ALINED OVENS                         |                |
| 1351150900 | SÚPRAVA NA VÝSTUHU PLATFORMY PECE až do 200 kgs<br>REINFORCED PLATFORM KIT up to 200 kgs |                |

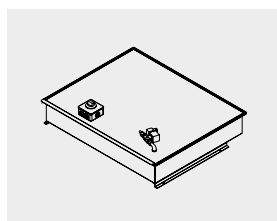

| AUTOMATICKÝ KONDENZÁTOR / AUTOMATIC CONDENSER |  |                |
|---|--|----------------|
| KÓD / Code                                    | POPIS / Description  | CENA / Price € |
| 1355010000                                    | AUTOMATICKÝ KONDENZÁTOR CV SK/14 *<br>AUTOMATIC CONDENSER CV-SK/14 * |                |

\* len pre elektrické pece  
\* For electric ovens only

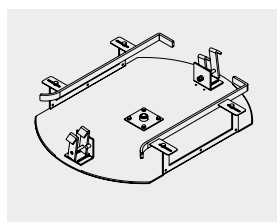

| UNIVERZÁLNA PLATFORMA - KARUSEL Pre vozíky od iných výrobcov ako SALVA<br>UNIVERSAL PLATFORM For racks not made by Salva |   |                |
|--|---|----------------|
| KÓD / Code   | POPIS / Description   | CENA / Price € |
| 1351920000   | UNIVERZÁLNA PLATFORMA - KARUSEL SK 20/02<br>UNIVERSAL PLATFORM SK 20/02 |                |

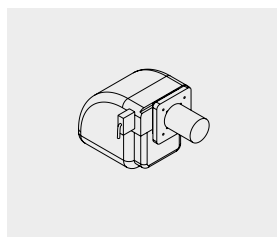

| HORÁK / BURNER |   |                |
|----------------|---|----------------|
| KÓD / Code     | POPIS / Description   | CENA / Price € |
| 4070500103     | HORÁK CUENOD FC6 GX 107/8 (SK-G)<br>BURNER CUENOD FC6 GX 107/8 (SK-G)       |                |
| 4070500108     | HORÁK CUENOD FC6 H 101 OLEJ (SK-O)<br>BURNER CUENOD FC6 H 101 GASOIL (SK-O) |                |

| INÉ / OTHERS |                               |                |
|--------------|-------------------------------|----------------|
| KÓD / Code   | POPIS / Description           | CENA / Price € |
| 0072900001   | EXTRA BZUČIAK<br>EXTRA BUZZER |                |

# Sirocco SR

## Rotačná (karuselová) pec / Rack rotating oven

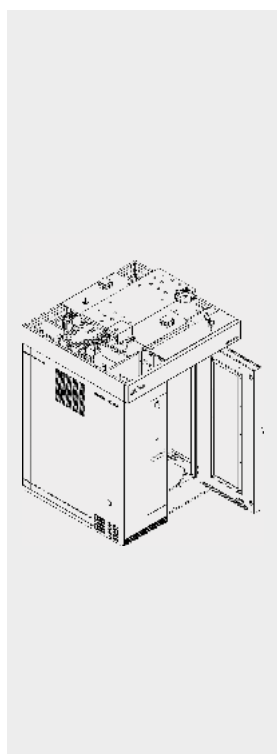

| UMIESTNENIE VÝMENNÍKA TEPLA: VĽAVO / SITUATION OF HEAT EXCHANGER: LEFT<br>PRÍSTUP K HORÁKU: VPREDU / ACCES TO BURNER: FRONT |   |                |     |
|---|---|----------------|-----|
| KÓD / Code  | POPIS / Description   | CENA / Price € |     |
|   |   | Standard       | STC |
| 1331030001  | SR-21-C+V/14 400V Bez horáku<br>SR-21-C+V/14 400V Without burner                        |                |     |
| 1331030000  | SR-21-C+V/14 230V Bez horáku<br>SR-21-C+V/14 230V Without burner                        |                |     |
| 1331040001  | SR-21-E+V/14 400V EL<br>SR-21-E+V/14 400V Electric                                      |                |     |
| 1331040000  | SR-21-E+V/14 230V EL<br>SR-21-E+V/14 230V Electric                                      |                |     |
| 1331020001  | SR-21-G+V/14 400V S plynovým horákom<br>SR-21-G+V/14 400V Includes gas burner           |                |     |
| 1331020000  | SR-21-G+V/14 230V S plynovým horákom<br>SR-21-G+V/14 230V Includes gas burner           |                |     |
| 1331026000  | SR-21-G+V/14 230V 60HZ S plynovým horákom<br>SR-21-G+V/14 230V 60HZ Includes gas burner |                |     |
| 1331010001  | SR-21-O+V/14 400V S olejovým horákom<br>SR-21-O+V/14 400V Includes diesel burner        |                |     |
| 1331010000  | SR-21-O+V/14 230V S olejovým horákom<br>SR-21-O+V/14 230V Includes diesel burner        |                |     |

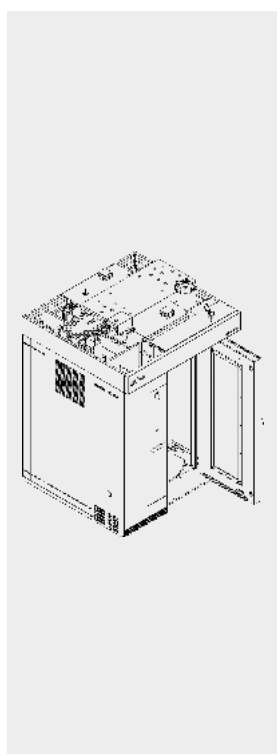

| UMIESTNENIE VÝMENNÍKA TEPLA: VZADU / SITUATION OF HEAT EXCHANGER:<br>PRÍSTUP K HORÁKU: VPRAVO / ACCES TO BURNER: RIGHT |   |                |     |
|--|---|----------------|-----|
| KÓD / Code   | POPIS / Description   | CENA / Price € |     |
|  |   | Standard       | STC |
| 1331430001   | SR-22-C+V/14 400V Bez horáku<br>SR-22-C+V/14 400V Without burner                        |                |     |
| 1331430000   | SR-22-C+V/14 230V Bez horáku<br>SR-22-C+V/14 230V Without burner                        |                |     |
| 1331440001   | SR-22-E+V/14 400V EL<br>SR-22-E+V/14 400V Electric                                      |                |     |
| 1331440000   | SR-22-E+V/14 230V EL<br>SR-22-E+V/14 230V Electric                                      |                |     |
| 1331420001   | SR-22-G+V/14 400V S plynovým horákom<br>SR-22-G+V/14 400V Includes gas burner           |                |     |
| 1331420000   | SR-22-G+V/14 230V S plynovým horákom<br>SR-22-G+V/14 230V Includes gas burner           |                |     |
| 1331426000   | SR-22-G+V/14 230V 60HZ S plynovým horákom<br>SR-22-G+V/14 230V 60HZ Includes gas burner |                |     |
| 1331410001   | SR-22-O+V/14 400V S olejovým horákom<br>SR-22-O+V/14 400V Includes diesel burner        |                |     |
| 1331410000   | SR-22-O+V/14 230V S olejovým horákom<br>SR-22-O+V/14 230V Includes diesel burner        |                |     |

Horno Sirocco a 60hz + 3%.  
Sirocco oven at 60hz + 3%.

# Sirocco SR

## Rotačná (karuselová) pec / Rack rotating oven

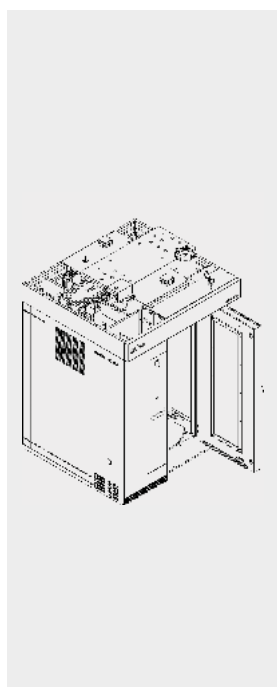

| UMIESTNENIE VÝMENNÍKA TEPLA: VZADU / SITUATION OF HEAT EXCHANGER: BACK |  |                |     |
|--|--|----------------|-----|
| PRÍSTUP K HORÁKU: VĽAVO / ACCES TO BURNER: LEFT                        |  |                |     |
| KÓD / Code   | POPIS / Description  | CENA / Price € |     |
|  |  | Standard       | STC |
| 1331730001   | SR-23-C+V/14 400V Bez horáku<br>SR-23-C+V/14 400V Without burner                 |                |     |
| 1331730000   | SR-23-C+V/14 230V Bez horáku<br>SR-23-C+V/14 230V Without burner                 |                |     |
| 1331740001   | SR-23-E+V/14 400V EL<br>SR-23-E+V/14 400V Electric                               |                |     |
| 1331740000   | SR-23-E+V/14 230V EL<br>SR-23-E+V/14 230V Electric                               |                |     |
| 1331720001   | SR-23+G+V/14 400V S plynovým horákom<br>SR-23+G+V/14 400V Includes gas burner    |                |     |
| 1331720000   | SR-23+G+V/14 230V S plynovým horákom<br>SR-23+G+V/14 230V Includes gas burner    |                |     |
| 1331710001   | SR-23-O+V/14 400V S olejovým horákom<br>SR-23-O+V/14 400V Includes diesel burner |                |     |
| 1331710000   | SR-23-O+V/14 230V S olejovým horákom<br>SR-23-O+V/14 230V Includes diesel burner |                |     |

Horno Sirocco a 60hz + 3%.

Horno Sirocco a 60hz + 3%

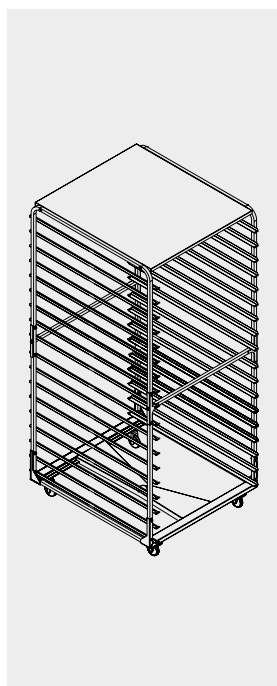

| ZAVÁŽACÍ VOZÍK / RACK |   |                |
|-----------------------|---|----------------|
| KÓD / Code            | POPIS / Description   | CENA / Price € |
| 2040210000            | BSR-14/03 80X60 (14 zásuvov 80x60)<br>BSR-14/03 80X60 (14 levels 80x60)   |                |
| 2040220000            | BSR-16/03 80X60 (16 zásuvov 80x60)<br>BSR-16/03 80X60 (16 levels 80x60)   |                |
| 2040230000            | BSR-18/03 80X60 (18 zásuvov 80x60)<br>BSR-18/03 80X60 (18 levels 80x60)   |                |
| 2040240000            | BSR-20/03 80X60 (20 zásuvov 80x60)<br>BSR-20/03 80X60(20 levels 80x60)  |                |
| 2040224000            | BSR-16/19 80X60 (16 zásuvov 80x60) VYSTUŽENÉ - VYŠŠIA ZÁŤAŽ<br>BSR-16/19 80X60 (16 levels 80x60) REINFORCED HIGH LOAD |                |

# Sirocco SR

Rotačná (karuselová) pec / Rack rotating oven

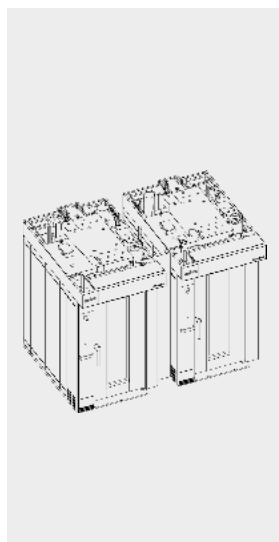

| KIT / KIT  |   |                |
|------------|---|----------------|
| KÓD / Code | POPIS / Description   | CENA / Price € |
| 1330013013 | MOTORIZOVANÝ DYMOVOD SIR/14<br>MOTORIZED FLUE SIR/14                                    |                |
| 1331016100 | INTEGROVANÝ SYSTÉM ODVODU SPALÍN SR-21<br>IES (INTEGRATED EXHAUST SYSTEM) SR-21         |                |
| 1331416100 | INTEGROVANÝ SYSTÉM ODVODU SPALÍN SR-22-23<br>IES (INTEGRATED EXHAUST SYSTEM) SR-22-23   |                |
| 1331413008 | KIT SR-G,O/14 SPOJENIE SÚSTAVY PECÍ<br>KIT SR-G,O/14 OF ALINED OVENS                    |                |
| 1331443001 | KIT SR-E/14 SPOJENIE SÚSTAVY PECÍ<br>KIT SR-E/14 OF ALINED OVENS                        |                |
| 1371150900 | SÚPRAVA NA VÝSTUHU PLATFORMY PECE až do 300 kg<br>REINFORCED PLATFORM KIT up to 300 kgs |                |

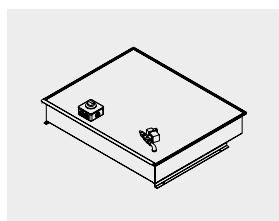

| AUTOMATICKÝ KONDENZÁTOR / AUTOMATIC CONDENSER |  |                |
|---|--|----------------|
| KÓD / Code                                    | POPIS / Description  | CENA / Price € |
| 1331016001                                    | AUTOMATICKÝ KONDENZÁTOR CV SR/14 *<br>AUTOMATIC CONDENSER CV-SR/14 * |                |

\* Len pre EL pece  
\* For electric ovens only

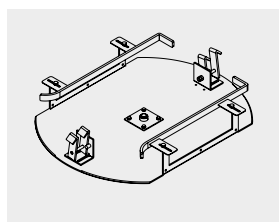

| UNIVERZÁLNA PLATFORMA - KARUSEL Pre vozíky od iných výrobcov ako SALVA<br>UNIVERSAL PLATFORM For racks not made by Salva |   |                |
|--|---|----------------|
| KÓD / Code   | POPIS / Description   | CENA / Price € |
| 1371920000   | UNIVERZÁLNA PLATFORMA SR 20/03<br>UNIVERSAL PLATFORM SR 20/03 |                |

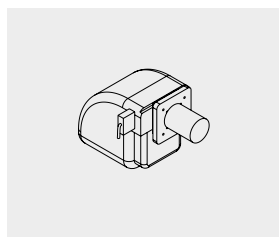

| HORÁK / BURNER |   |                |
|----------------|---|----------------|
| KÓD / Code     | POPIS / Description   | CENA / Price € |
| 4070500101     | HORÁK CUENOD FC9 GX 107/8 (SR-G)<br>BURNER CUENOD FC9 GX 107/8 (SR-G) |                |
| 4070500104     | HORÁK CUENOD FC9 H 101 (SR-O)<br>BURNER CUENOD FC9 H 101 (SR-O)       |                |

| INÉ / OTHERS |                               |                |
|--------------|-------------------------------|----------------|
| KÓD / Code   | POPIS / Description           | CENA / Price € |
| 0072900001   | EXTRA BZUČIAK<br>EXTRA BUZZER |                |

# Sirocco SP

## Rotačná (karuselová) pec / Rack rotating oven

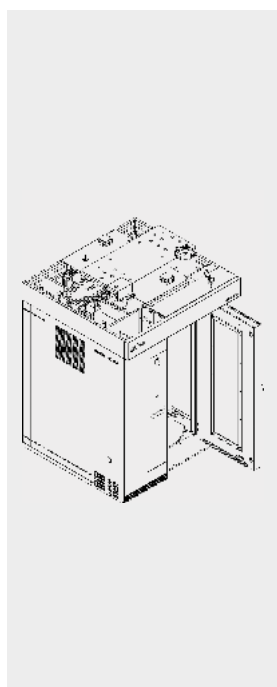

**UMIESTNENIE VÝMENNÍKA TEPLA: VĽAVO / SITUATION OF HEAT EXCHANGER: LEFT**  
**PRÍSTUP K HORÁKU: Z PREDNEJ STRANY / ACCES TO BURNER: FRONT**

| KÓD / Code | POPIS / Description  | CENA / Price € |     |
|------------|--|----------------|-----|
|            |  | Standard       | STC |
| 1332030001 | SP-21-C+V/14 400V Bez horáku<br>SP-21-C+V/14 400V Without burner                 |                |     |
| 1332030000 | SP-21-C+V/14 230V Bez horáku<br>SP-21-C+V/14 230V Without burner                 |                |     |
| 1332040001 | SP-21-E+V/14 400V EL<br>SP-21-E+V/14 400V Electric                               |                |     |
| 1332040000 | SP-21-E+V/14 230V EL<br>SP-21-E+V/14 230V Electric                               |                |     |
| 1332020001 | SP-21-G+V/14 400V S plynovým horákom<br>SP-21-G+V/14 400V Includes gas burner    |                |     |
| 1332020000 | SP-21-G+V/14 230V S plynovým horákom<br>SP-21-G+V/14 230V Includes gas burner    |                |     |
| 1332010001 | SP-21-O+V/14 400V S olejovým horákom<br>SP-21-O+V/14 400V Includes diesel burner |                |     |
| 1332010000 | SP-21-O+V/14 230V S olejovým horákom<br>SP-21-O+V/14 230V Includes diesel burner |                |     |

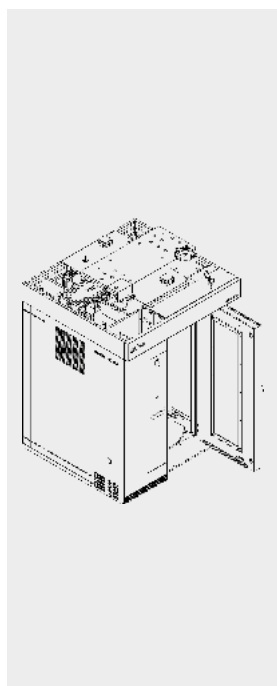

**UMIESTNENIE VÝMENNÍKA TEPLA: VZADU / SITUATION OF HEAT EXCHANGER: BACK**  
**PRÍSTUP K HORÁKU: VPRAVO / ACCES TO BURNER: RIGHT**

| KÓD / Code | POPIS / Description  | CENA / Price € |     |
|------------|--|----------------|-----|
|            |  | Standard       | STC |
| 1332430001 | SP-22-C+V/14 400V Bez horáku<br>SP-22-C+V/14 400V Without burner                 |                |     |
| 1332430000 | SP-22-C+V/14 230V Bez horáku<br>SP-22-C+V/14 230V Without burner                 |                |     |
| 1332440001 | SP-22-E+V/14 400V EL<br>SP-22-E+V/14 400V Electric                               |                |     |
| 1332440000 | SP-22-E+V/14 230V EL<br>SP-22-E+V/14 400V Electric                               |                |     |
| 1332420001 | SP-22-G+V/14 400V S plynovým horákom<br>SP-22-G+V/14 400V Includes gas burner    |                |     |
| 1332420000 | SP-22-G+V/14 230V S plynovým horákom<br>SP-22-G+V/14 230V Includes gas burner    |                |     |
| 1332410001 | SP-22-O+V/14 400V S olejovým horákom<br>SP-22-O+V/14 400V Includes diesel burner |                |     |
| 1332410000 | SP-22-O+V/14 230V S olejovým horákom<br>SP-22-O+V/14 230V Includes diesel burner |                |     |

Horno Sirocco a 60hz + 3%.  
Sirocco oven at 60hz + 3%.

# Sirocco SP

Rotačná (karuselová) pec / Rack rotating oven

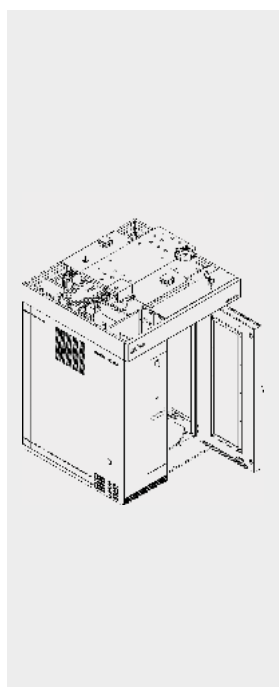

| UMIESTNENIE VÝMENNÍKA TEPLA: VZADU / SITUATION OF HEAT EXCHANGER:<br>PRÍSTUP K HORÁKU: VLEAVO / ACCES TO BURNER: LEFT |  |                |     |
|---|--|----------------|-----|
| KÓD / Code  | POPIS / Description  | CENA / Price € |     |
|   |  | Standard       | STC |
| 1332730001  | SP-23-C+V/14 400V Bez horáku<br>SP-23-C+V/14 400V Without burner                 |                |     |
| 1332730000  | SP-23-C+V/14 230V Bez horáku<br>SP-23-C+V/14 230V Without burner                 |                |     |
| 1332740001  | SP-23-E+V/14 400V EL<br>SP-23-E+V/14 400V Electric                               |                |     |
| 1332740000  | SP-23-E+V/14 230V EL<br>SP-23-E+V/14 230V Electric                               |                |     |
| 1332720001  | SP-23+G+V/14 400V S plynovým horákom<br>SP-23+G+V/14 400V Includes gas burner    |                |     |
| 1332720000  | SP-23+G+V/14 230V S plynovým horákom<br>SP-23+G+V/14 230V Includes gas burner    |                |     |
| 1332710001  | SP-23-O+V/14 400V S olejovým horákom<br>SP-23-O+V/14 400V Includes diesel burner |                |     |
| 1332710000  | SP-23-O+V/14 230V S olejovým horákom<br>SP-23-O+V/14 230V Includes diesel burner |                |     |

Horno Sirocco a 60hz + 3%.  
Sirocco oven at 60hz + 3%.

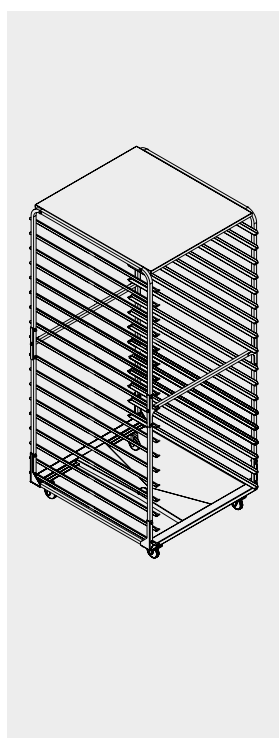

| ZAVÁŽACÍ VOZÍK / RACK |   |                |
|-----------------------|---|----------------|
| KÓD / Code            | POPIS / Description   | CENA / Price € |
| 2041220000            | BSP-16/03 100X80 (16 zásuvov 100x80)<br>BSP-16/03 100X80 (16 levels 100x80)   |                |
| 2041230000            | BSP-18/03 100X80 (18 zásuvov 100x80)<br>BSP-18/03 100X80 (18 levels 100x80)   |                |
| 2041240000            | BSP-20/03 100X80 (20 zásuvov 100X80)<br>BSP-20/03 100X80 (20 levels 100X80)   |                |
| 2041236646            | BSP-18/03 2-66X46 (18 zásuvov 2-66x46)<br>BSP-18/03 2-66X46 (18 levels 2-66x46)   |                |
| 2041246646            | BSP-20/03 2-66X46 (20 zásuvov 2-66x46)<br>BSP-20/03 2-66X46 (20 levels 2-66x46)   |                |
| 2041223000            | BSP-16/19 100X80 (16 zásuvov 100x80) VYSTUŽENÉ - VYŠŠIA ZÁŤAŽ<br>BSP-16/19 100X80 (16 levels 100x80) REINFORCED HIGH LOAD |                |

# Sirocco SP

Rotačná (karuselová) pec / Rack rotating oven

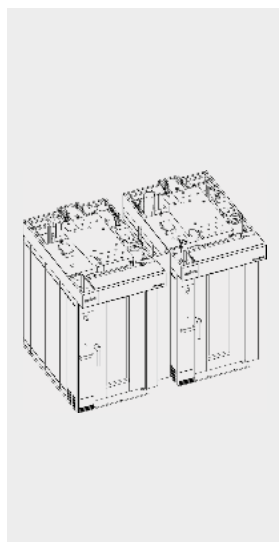

| KIT / KIT  |   |                |
|------------|---|----------------|
| KÓD / Code | POPIS / Description   | CENA / Price € |
| 1330013013 | MOTORIZOVANÝ DYMOVOD SIR/14<br>MOTORIZED FLUE SIR/14                                    |                |
| 1332016100 | INTEGROVANÝ SYSTÉM ODVODU SPALÍN SP-21<br>IES (INTEGRATED EXHAUST SYSTEM) SP-21         |                |
| 1332416100 | INTEGROVANÝ SYSTÉM ODVODU SPALÍN SP-22-23<br>IES (INTEGRATED EXHAUST SYSTEM) SP-22-23   |                |
| 1332413008 | KIT SP-G,O/14 SPOJENIE SÚSTAVY PECÍ<br>KIT SP-G,O/14 OF ALINED OVENS                    |                |
| 1332443001 | KIT SP-E/14 SPOJENIE SÚSTAVY PECÍ<br>KIT SP-E/14 OF ALINED OVENS                        |                |
| 1381150900 | SÚPRAVA NA VÝSTUHU PLATFORMY PECE až do 400 kg<br>REINFORCED PLATFORM KIT up to 400 kgs |                |

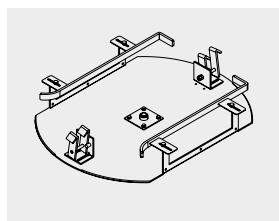

| UNIVERZÁLNA PLATFORMA - KARUSEL Pre vozíky od iných výrobcov ako SALVA<br>UNIVERSAL PLATFORM For racks not made by Salva |   |                |
|--|---|----------------|
| KÓD / Code   | POPIS / Description   | CENA / Price € |
| 1381920000   | UNIVERZÁLNA PLATFORMA SP 20/03<br>UNIVERSAL PLATFORM SP 20/03 |                |

| PLA TAFORMA - KARUSEL NA DVA VOZÍKY / PLATFORM 2 BALLS |  |                |
|--|--|----------------|
| KÓD / Code   | POPIS / Description  | CENA / Price € |
| 1381820000   | PLATFORMA SP 20/14 PRE 2 VOZÍKY<br>PLATFORM SP 20/14 2 BALLS |                |

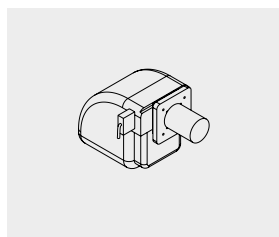

| HORÁK / BURNER |   |                |
|----------------|---|----------------|
| KÓD / Code     | POPIS / Description   | CENA / Price € |
| 4070500105     | HORÁK CUENOD FC12 GX 107/8 (SP-G)<br>BURNER CUENOD FC12 GX 107/8 (SP-G) |                |
| 4070500102     | HORÁK CUENOD FC12 H 101 (SP-O)<br>BURNER CUENOD FC12 H101 (SP-O)        |                |

| INÉ / OTHERS |                               |                |
|--------------|-------------------------------|----------------|
| KÓD / Code   | POPIS / Description           | CENA / Price € |
| 0072900001   | EXTRA BZUČIAK<br>EXTRA BUZZER |                |